

# SHREDDERS

WITH SINGLE-SHAFT TECHNOLOGY

SERIES WLK JUMBO | SUPER JUMBO

# HIGH DEMANDS? BRING IT ON!



SHREDDERS OF THE WLK JUMBO / SUPER JUMBO SERIES ARE DESIGNED FOR EXTREME TASKS AND MAXIMUM THROUGHPUT.



## RAM SHOCK VALVE

→ Absorbs ram shocks and protects cylinders

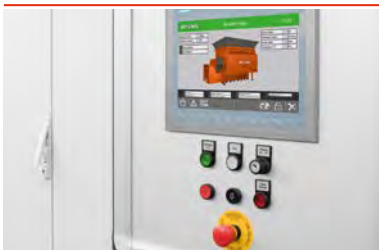

## CONTROL CABINET

→ Energy efficient size reduction and good usability with Siemens PLC control



## THREE DIFFERENT DRIVE OPTIONS

→ All machines are available with hydraulic drive, electromechanical drive or direct drive

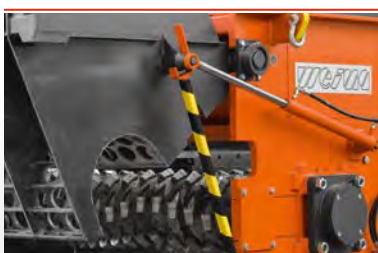

## LIFT UP SCREEN BASKET

→ Pivoted hydraulically // For easy maintenance access and change of screen basket

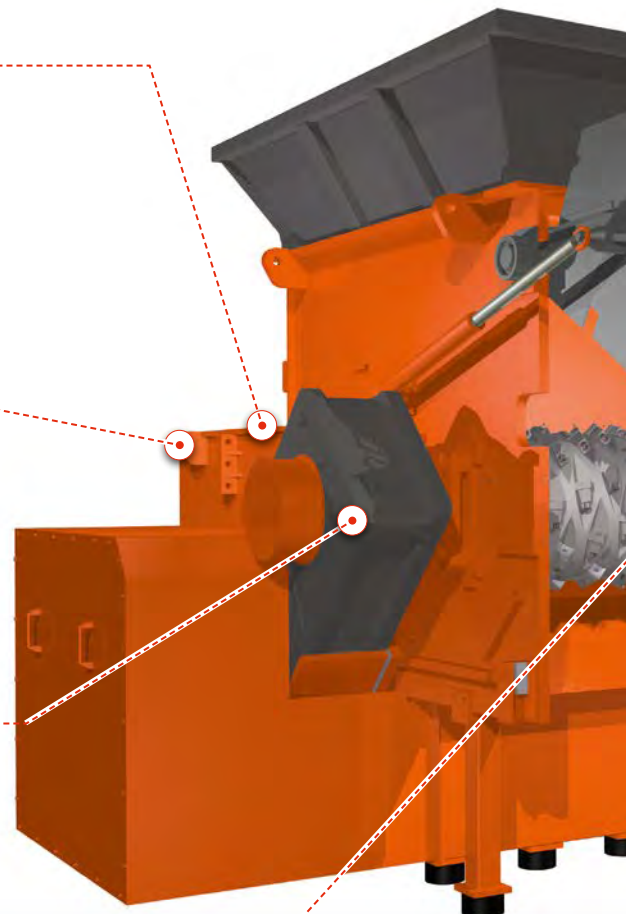



### V-ROTOR

- Innovative V-Rotor // All-purpose // High throughput // Low energy consumption // Low wear costs



### F-ROTOR

- Controlled feeding // Precise cutting // Available with bolted or welded knife holders



### OFFSET BEARING

- Dustproof // Sturdy design // Maintenance-friendly



### SEGMENTED FLOOR GUIDANCE

- Precise guidance of ram // Ideal for very thin material

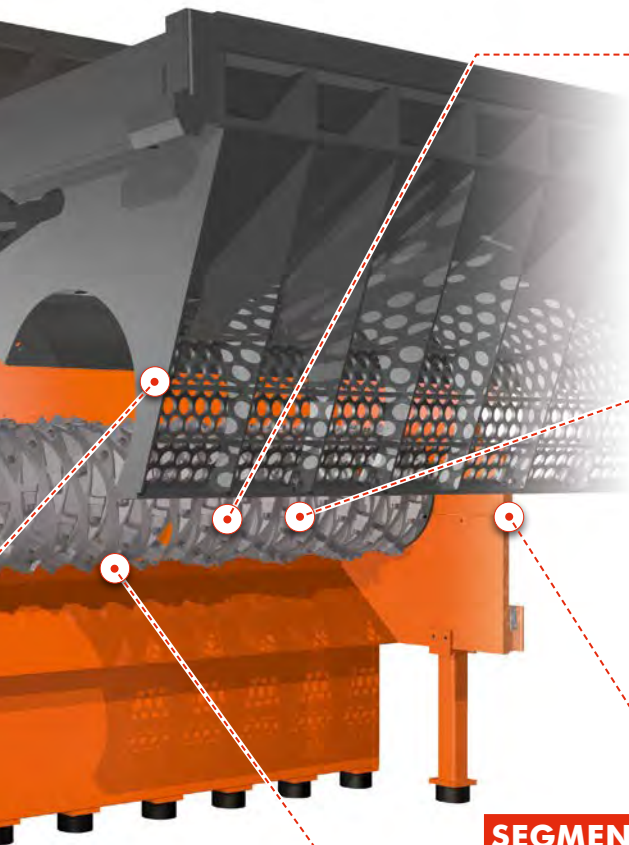

# THE DRIVE MAKES THE DIFFERENCE.

## THREE CONCEPTS FOR YOUR SUCCESS.

---

With intelligent shredding technology from WEIMA, waste material is transformed into revenue material suitable for re-use in the secondary commodity markets. For several decades our size reduction technology has been utilized to process large objects into a small homogeneous size. Our broad range of shredder machinery provides the capability to efficiently shred materials such as plastics, wood, paper and cardboard, metal, biomass, waste or data storage media.



### **HYDRAULIC DRIVE**

This drive is designed for extreme applications. Speed and torque can be adapted to the material to be shredded, without undesirable current peaks. The available drive power can be applied optimally, reducing power consumption by as much as 30 percent.

### **DIRECT DRIVE**

Direct drives are characterized by their high torque density in the low and medium rotational speed ranges. They feature a so-called planetary gearbox that is installed inside of the rotor. This makes the drive particularly compact. In conjunction with the high overload capacity and the outstanding smooth running characteristics of the drives, they can be used for challenging and dynamic applications. Thanks to integrated, stainless steel water cooling, the machine guarantees ideal dissipation of the waste while providing a high protection rating. The robust and compact motors are also largely maintenance-free, an additional benefit for cost-effective operation.

### **ELECTROMECHANICAL DRIVE**

The conventional drive uses a standard motor and an in-house developed WEIMA WAP gearbox regulating the rotational speed. The shoe-box shape of the new gearbox makes it very maintenance-friendly. By removing a single cover it is fully exposed. The main advantage of the gearbox is the fact that it has been set up specifically for the purpose of shredding. Standard gearboxes are designed for constant loading which is not applicable for industrial shredders.



WEIMA WLK 30 Super Jumbo with powerful hydraulic drive

# ROTOR AND CUTTING TECHNOLOGY.

SHARP INNOVATIONS FOR MAXIMUM THROUGHPUT.

The WLK Jumbo / Super Jumbo can be equipped with different rotor and knife designs. This choice depends on your type of material in order to customize the machine to achieve optimum results.

The grinding of the driven material takes place between the rotor knives and counter knives.

## YOUR ADVANTAGES

- Different cutting knife sizes: 40, 60, 80, 100 mm
- Precise adjustment of cutting knife and counter knife
- Made of the best material: hardened steel or carbide-tipped knives
- Optionally available with second counter knife
- Cutting knives and counter knives are rotatable



**FLAT** ▶ for general use

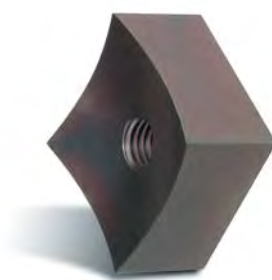

**CONCAVE** ▶ for better feeding

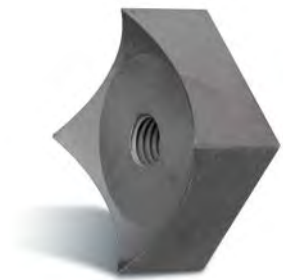

**EXTREME** ▶ for smoother cuts



**CROSSCUT** ▶ for more cuts

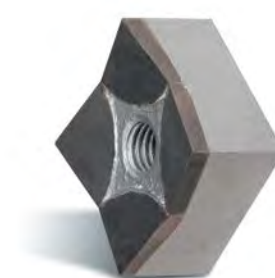

**CARBIDE** ▶ for increased wearability

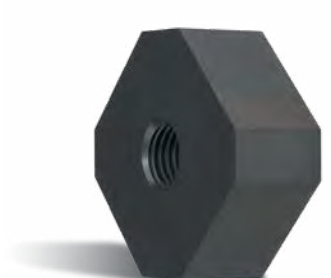

**TRAPEZOIDAL** ▶ for extreme applications

40, 60, 80, 100 mm (actual size)

# DIFFERENT MATERIALS?

NO PROBLEM FOR WEIMA'S WLK JUMBO / SUPER JUMBO.

In order to grind different materials efficiently, expert know-how and experience is important. The spectrum of projects is wide because of the variety of material, shapes, sizes and pollution degrees. It is important to

match the application requirements to a customized machine in order to achieve optimal results. This is what the WLK Jumbo / Super Jumbo has to offer!

## SAMPLE MATERIALS. PERFECTLY DISPOSED



**HARD PLASTICS** ▶ lumps, boxes, mouldings



**PAPER AND CARDBOARD** ▶ waste paper, cellulose, documents, packaging



**FILM** ▶ agricultural film, BOPP film, PVB film, composite film



**FIBERS** ▶ PA, polyester, aramid fibers, glass fiber, carbon fibers



**PIPES** ▶ pipelines, KG pipes, PE pipes, AS pipes



**WOOD** ▶ pallets, furniture, hard and soft wood, chipboard, MDF

### WLK 30 SUPER JUMBO

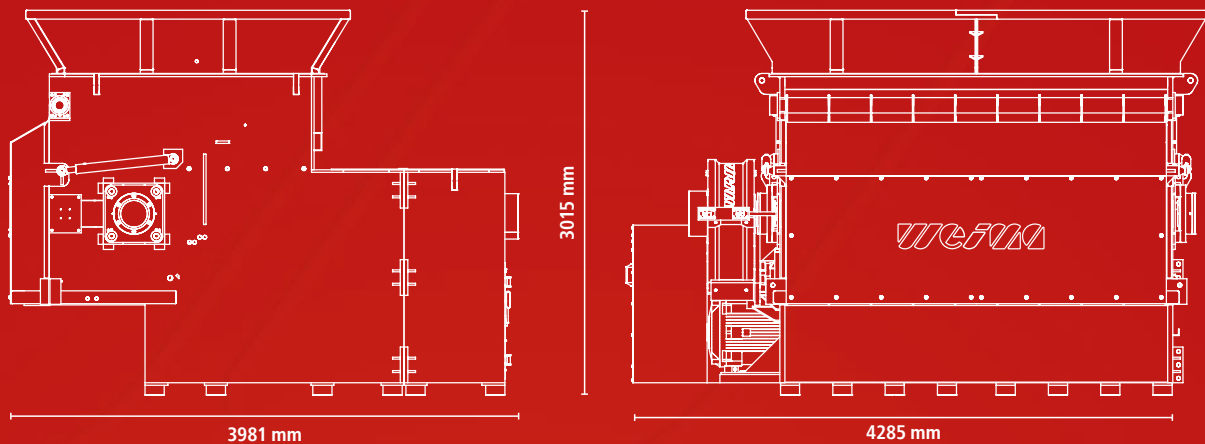

TECHNICAL SPECIFICATIONS		WLK 15 JUMBO	WLK 20 JUMBO	WLK 25 JUMBO
Feed opening	[mm]	1,500 × 1,880	2,000 × 1,880	2,500 × 1,880
Hopper volume	[m <sup>3</sup> ]	4.5	6	7.5
Rotor Ø	[mm]	500	500	500
Rotor width	[mm]	1,500	2,000	2,500
Motor performance	[kW]	75–110	90–160	110–250
Weight*	[approx. kg]	15,000	18,500	24,500

TECHNICAL SPECIFICATIONS		WLK 15 SUPER JUMBO	WLK 20 SUPER JUMBO	WLK 25 SUPER JUMBO	WLK 30 SUPER JUMBO
Feed opening	[mm]	1,500 × 1,930	2,000 × 1,930	2,500 × 1,930	3,000 × 1,930
Hopper volume	[m <sup>3</sup> ]	4.8	6.4	8	9.6
Rotor Ø	[mm]	700	700	700	700
Rotor width	[mm]	1,500	2,000	2,500	3,000
Motor performance	[kW]	75–110	90–160	110–250	110–250
Weight*	[approx. kg]	17,500	21,000	30,000	34,000

\* Exact weight varies according to configuration and drive capacity.

All models have a screen perforation of 10–100 mm and rotor RPM of 60–200.